

1. 1x



2. 1x  
(P2294)



3. 1x  
(V175)

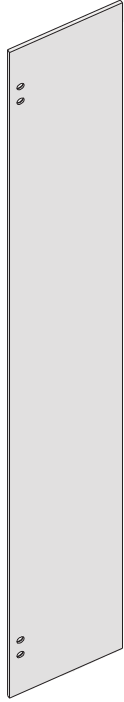

5. 1x  
(V177)

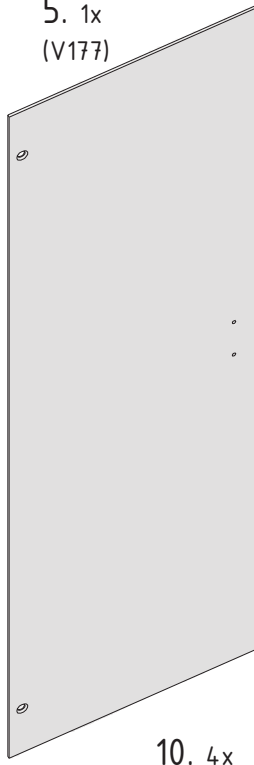

4.1x  
(P233)

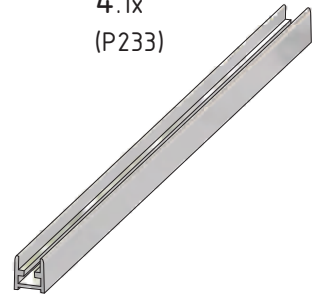

11. 1x  
(MA2969)

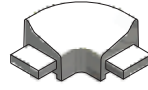

12. 1x  
(MA2974)



13. 1x  
(M9097)



7. 4x  
(M0511)



10. 4x  
(M5975)



8. 4x  
(M0811)



9. 4x  
(M5974)



14. 2x  
(P3648)

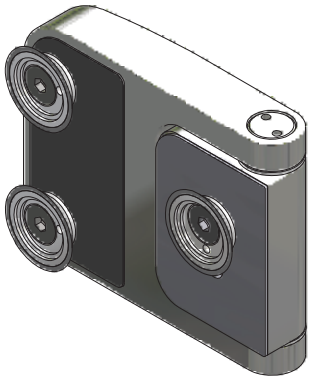

17. 1x  
(P3647)



28. 1x  
(M6645)

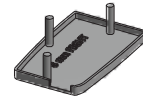

29. 1x  
(M6646)

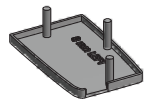

15. 6x  
(MA3702)



16. 1x  
(M4799)



26. 1x  
(P236)

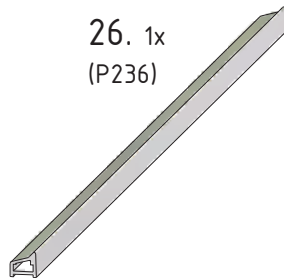

32. 4x  
(M5924)

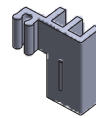

33. 4x  
(M5925)

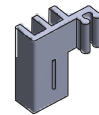

27. 2x  
(M1916)

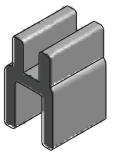

20. 1x  
(P235)

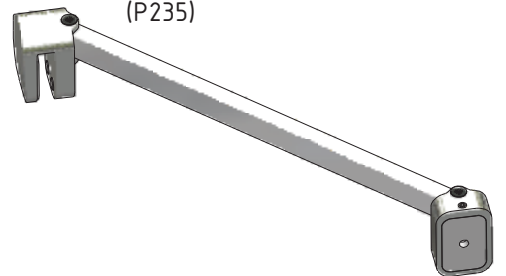

21. 1x  
(MB4831)

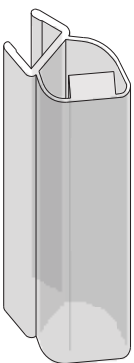

22. 1x  
(MB4832)

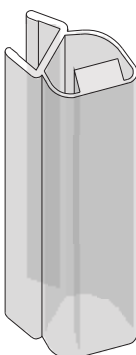

23. 1x  
(MA3645)

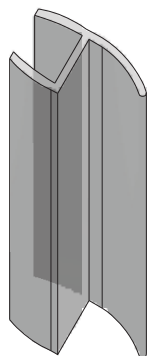

24. 1x  
(T37)

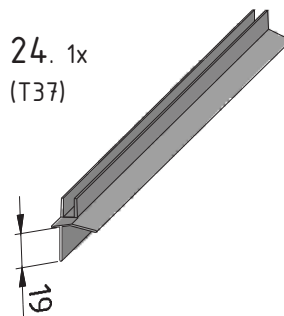

25. 1x  
(T36)

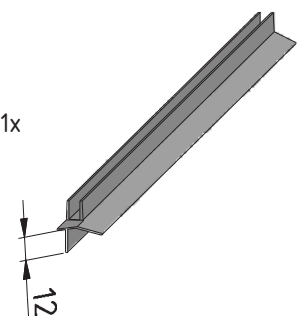

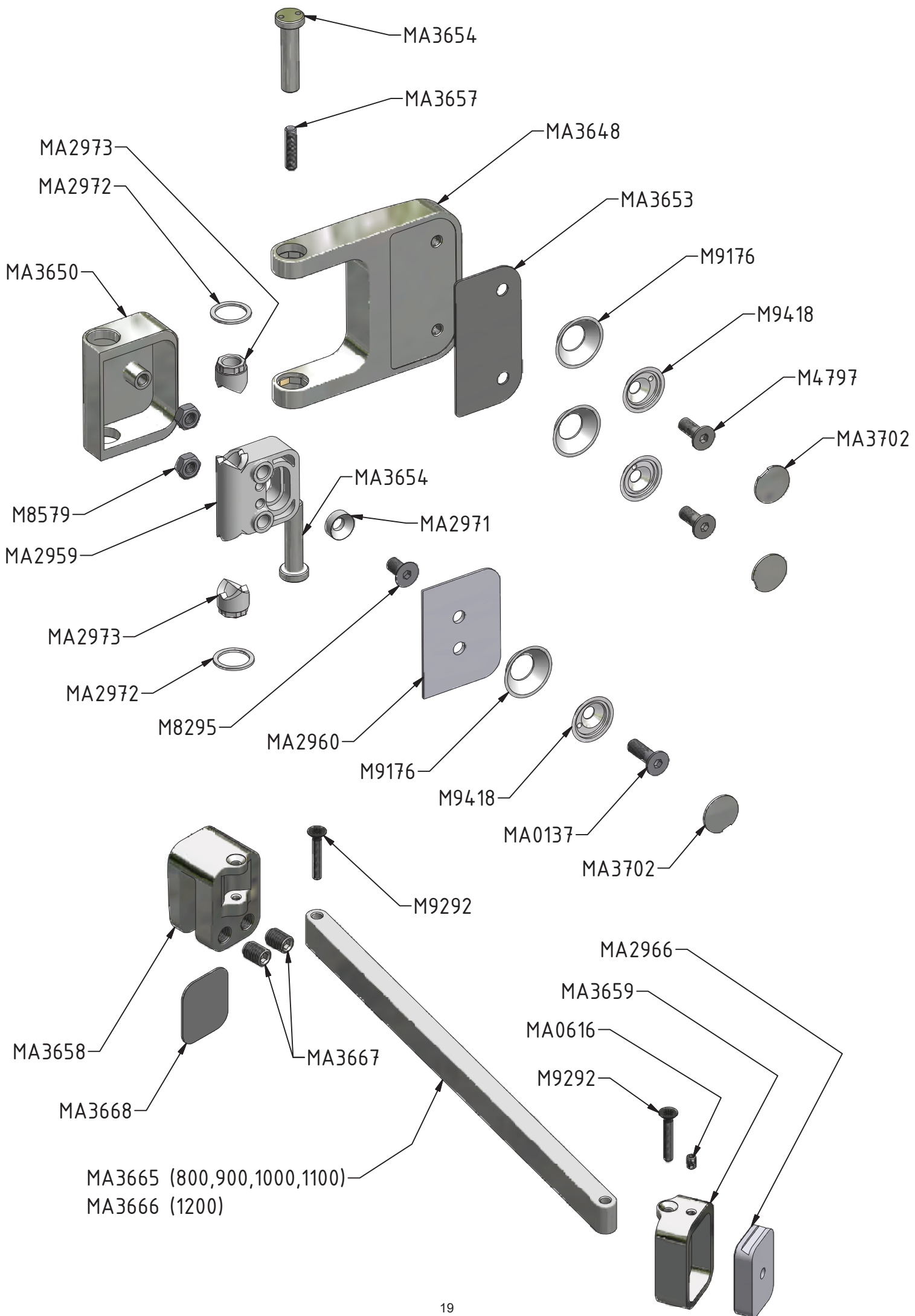

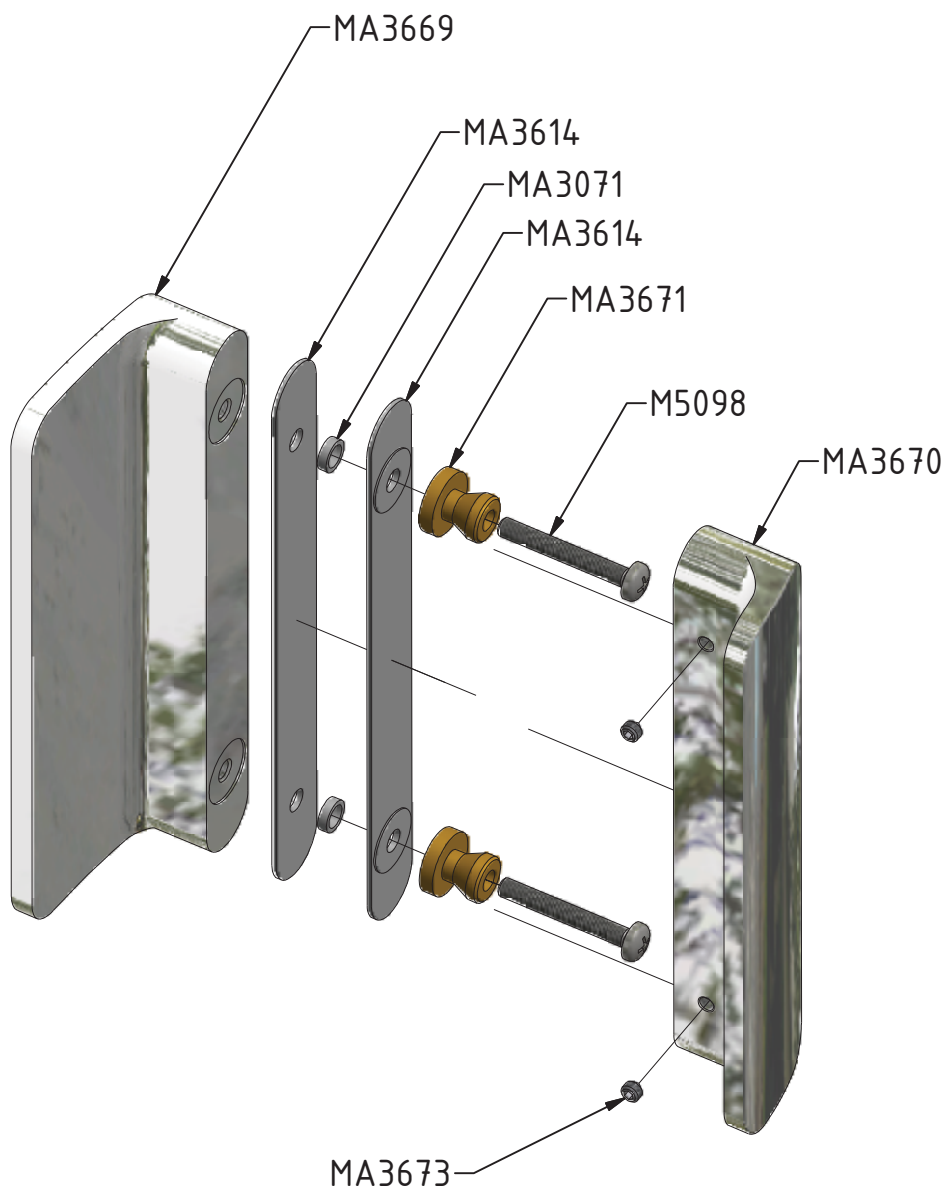

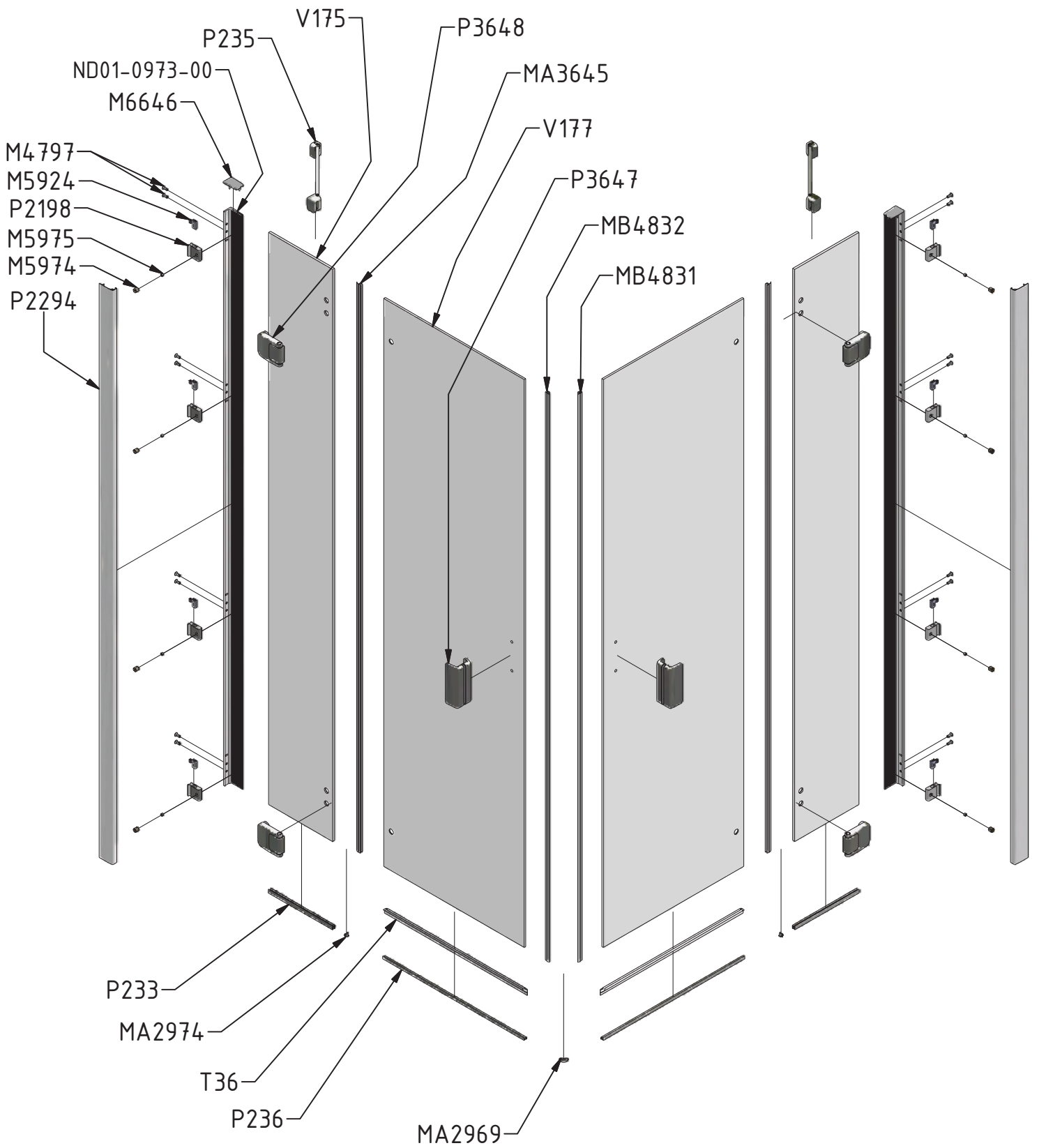

V175	800;900	clear glass	ND03-0657-02
	1000;1100	clear glass	ND03-0658-02
	1200	clear glass	ND03-0659-02
V177	800	clear glass	ND02-0741-02
	900;1000	clear glass	ND02-0742-02
	1100;1200	clear glass	ND02-0743-02
P235	800;900;1000;1100	brillant	P3645
	1200	brillant	P3646
P236	800	brillant	P3650
	900;1000	brillant	P3651
	1100;1200	brillant	P3652
P233	800;900	brillant	P3660
	1000;1100	brillant	P3661
	1200	brillant	P3662
T36	800		P3653
	900;1000		P3654
	1100;1200		P3655
T37	800		P3656
	900;1000		P3657
	1100;1200		P3658