

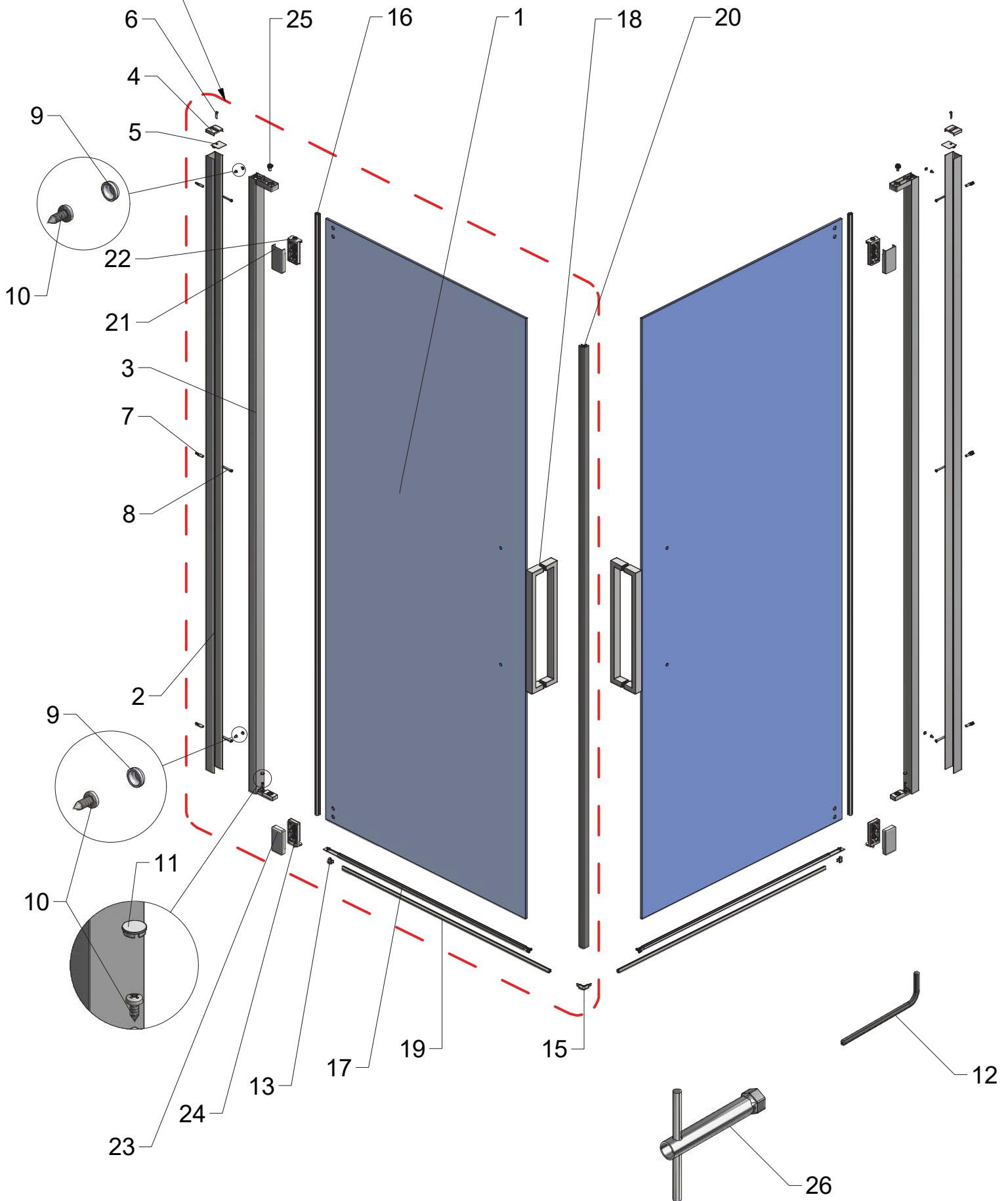

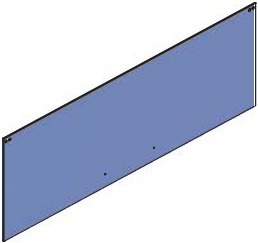







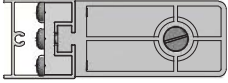
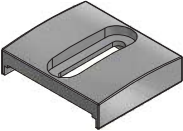
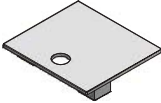







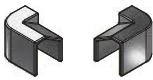



HI PI2

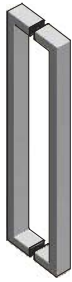

HI PI2

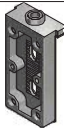
POS.	PREVIEW	PCS	SPARE PART
1		1	V278
2		1	ND01-4001
3		1	ND01-4000
4		1	ND01-3995
5		1	ND01-3995
6		1	ND01-3995
7		4	ND01-3995
8		3	ND01-3995
9		2	ND01-3995
10		3	ND01-3995
11		1	ND01-3995
12		1	ND01-3995
13		1+1 (SET)	ND01-3995
14		1	ND01-3995
15		1	ND01-3995

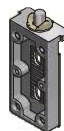
HI PI2

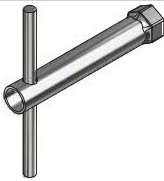
POS.	PREVIEW	PCS	SPARE PART
16		1	ND01-3996
17		1	ND01-3997
18		1	ND01-4003
19		1	ND01-4002
20		1+1 (SET)	ND01-3998
21		1	ND01-3999
22		1	ND01-3999
23		1	ND01-3999
24		1	ND01-3999
25		1	ND01-3999
26		1	-

ND01-3995

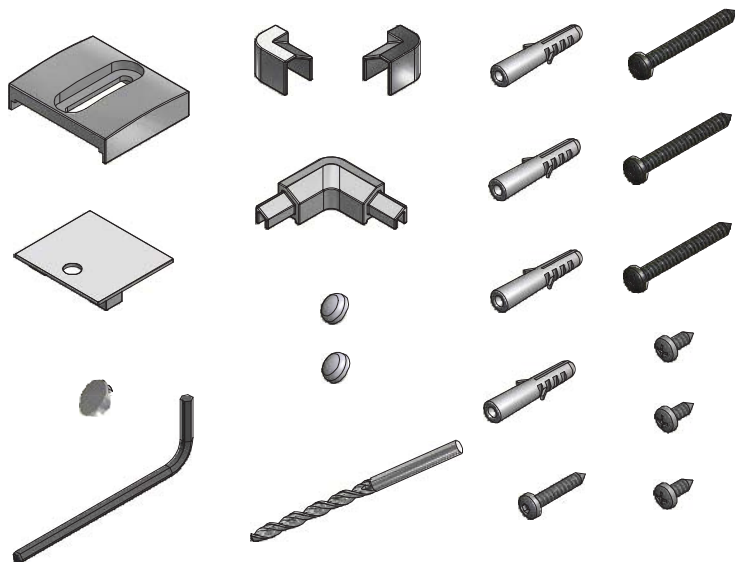

ND01-3996

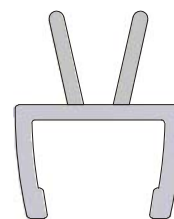

ND01-3997

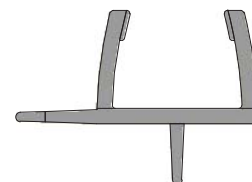

ND01-3998

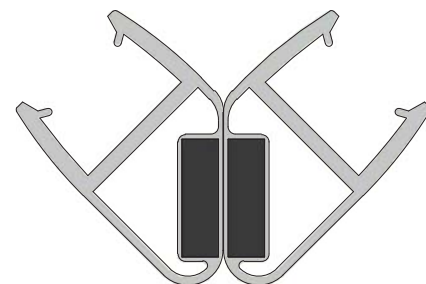

ND01-3999

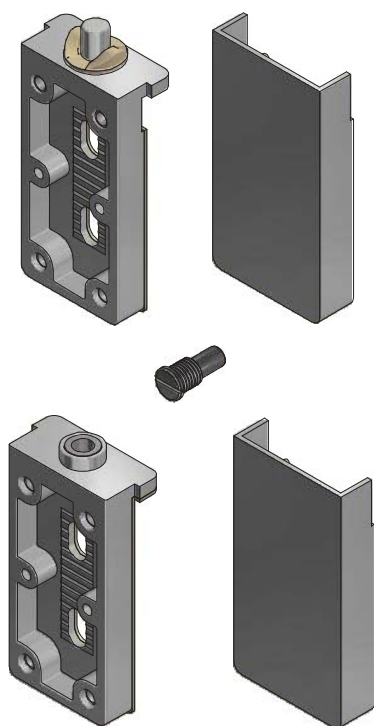

ND01-4000

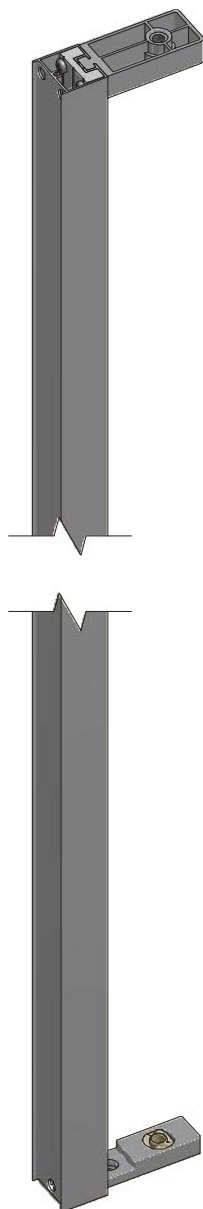

ND01-4001

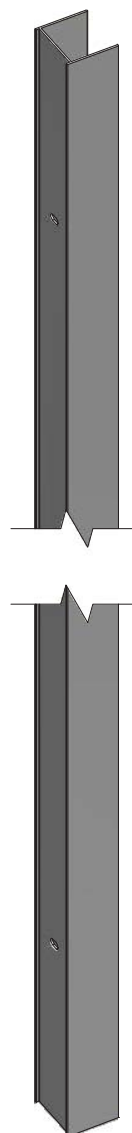

ND01-4002

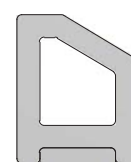

V278



ND01-4003

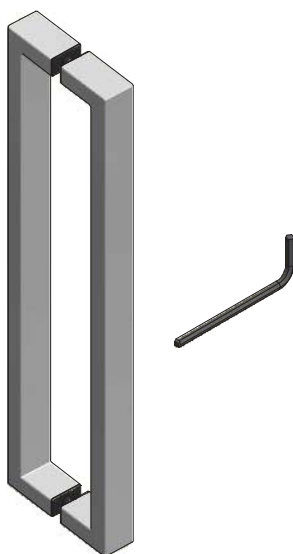

V278	800	Transparent	ND02-0894-02
	900		ND02-0895-02
	1000		ND02-0896-02