

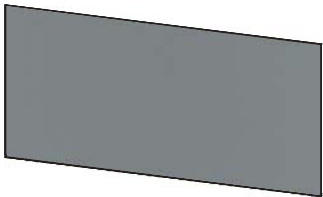









EI TWF

POS	PREVIEW	PCS	SPARE PART
1		1	V284
2		1	ND01-4075-00
3		1	ND01-4075-00
4		1	ND01-4073-00
5		1	ND01-4074-00
6		4	ND01-4074-00
7		4	ND01-4074-00
8		1	ND01-4074-00
9		1	ND01-4074-00
10		1	ND01-4074-00
11		3	ND01-4074-00

ND01-4074-00

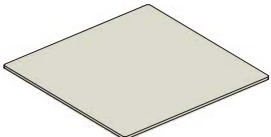
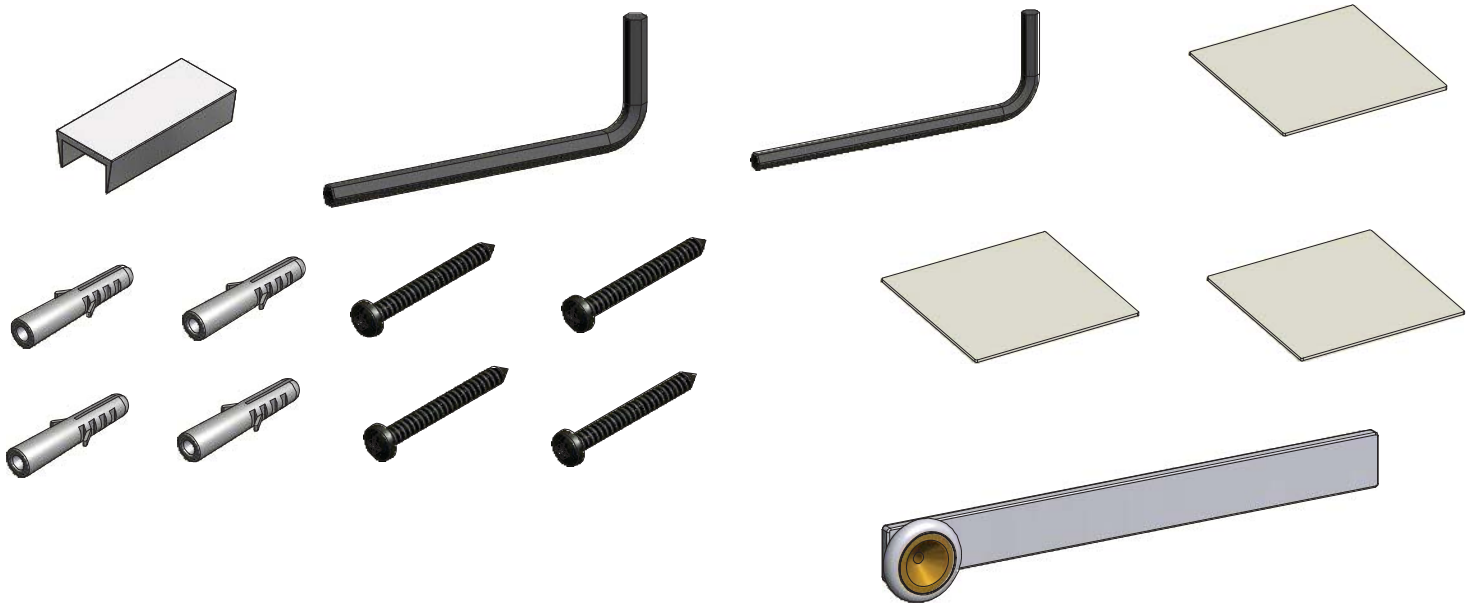

ND01-4075-00

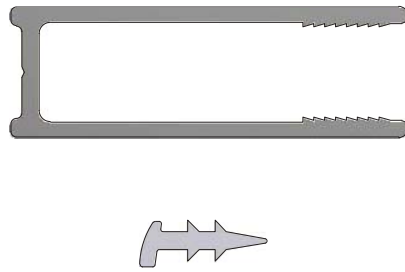

ND01-4073-00

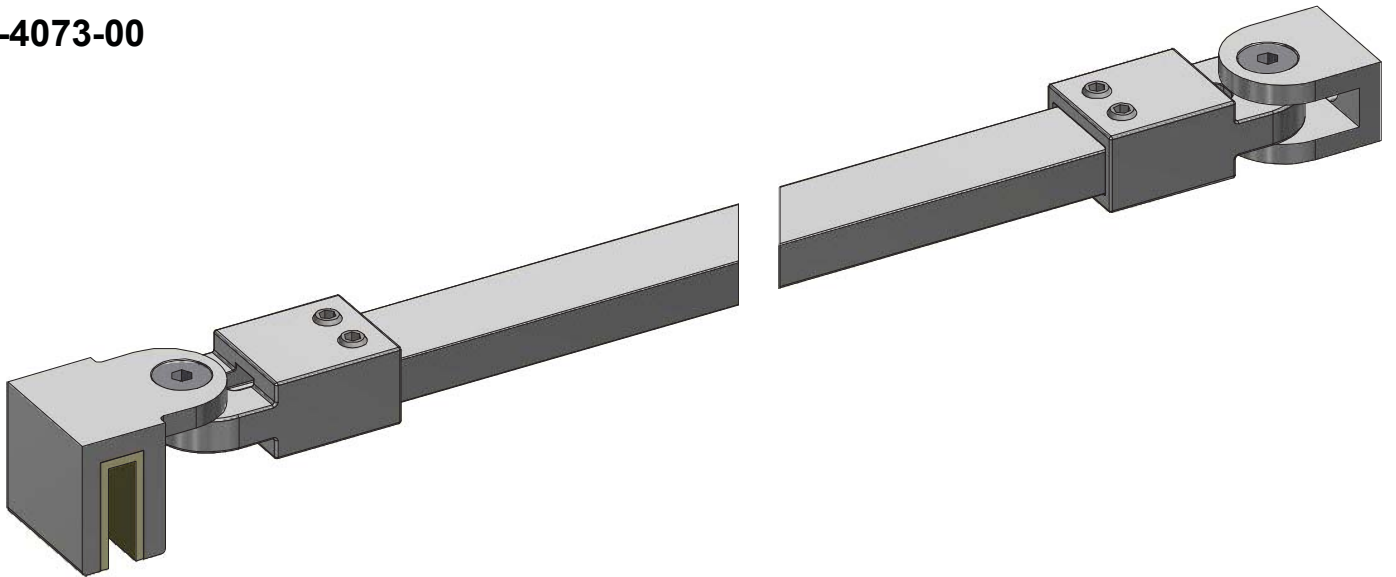

N0766

V284	800	Transparent	ND03-0895-02
	900		ND03-0896-02
	1000		ND03-0897-02
	1200		ND03-0898-02
	1400		ND03-0899-02