

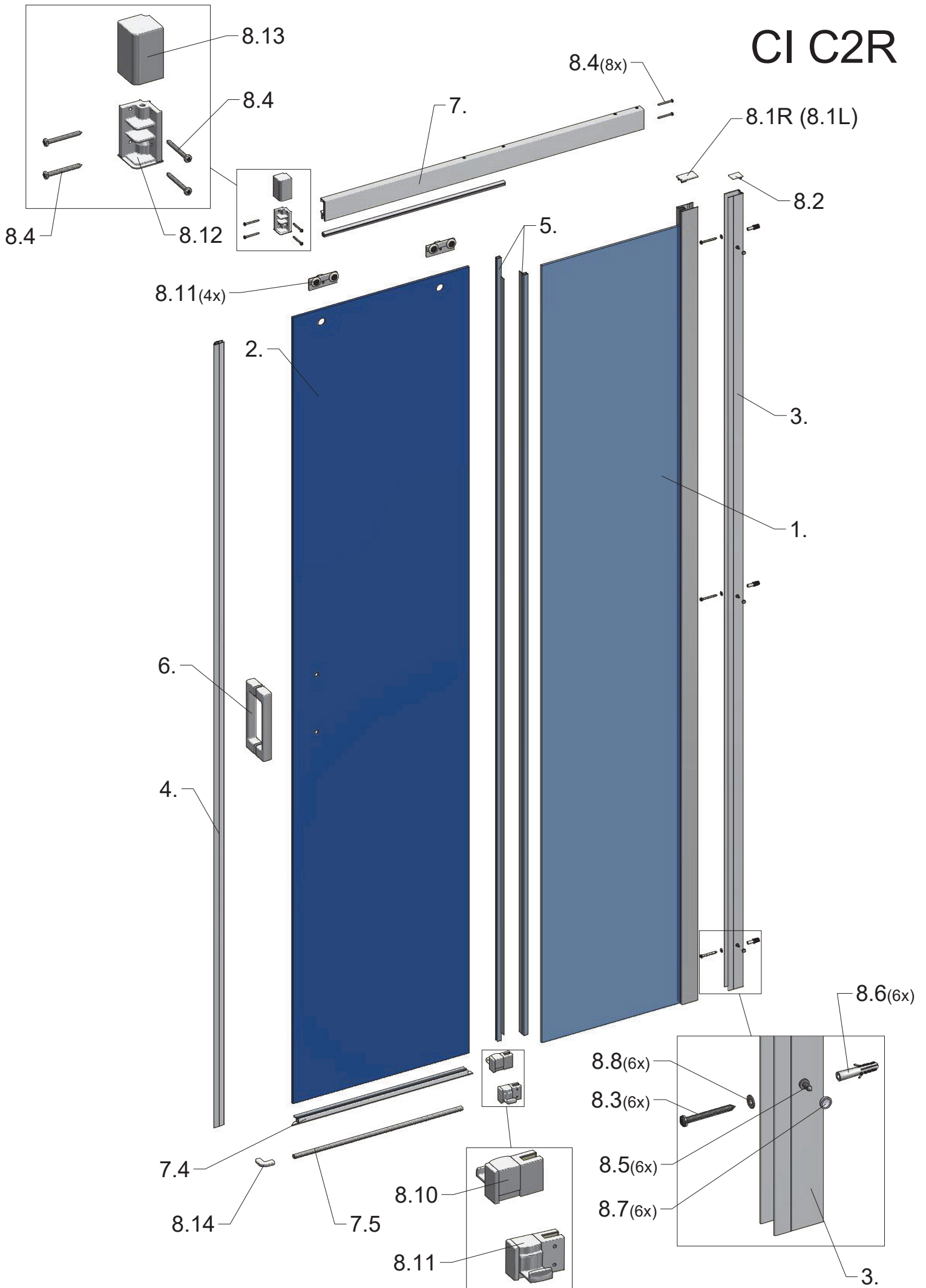

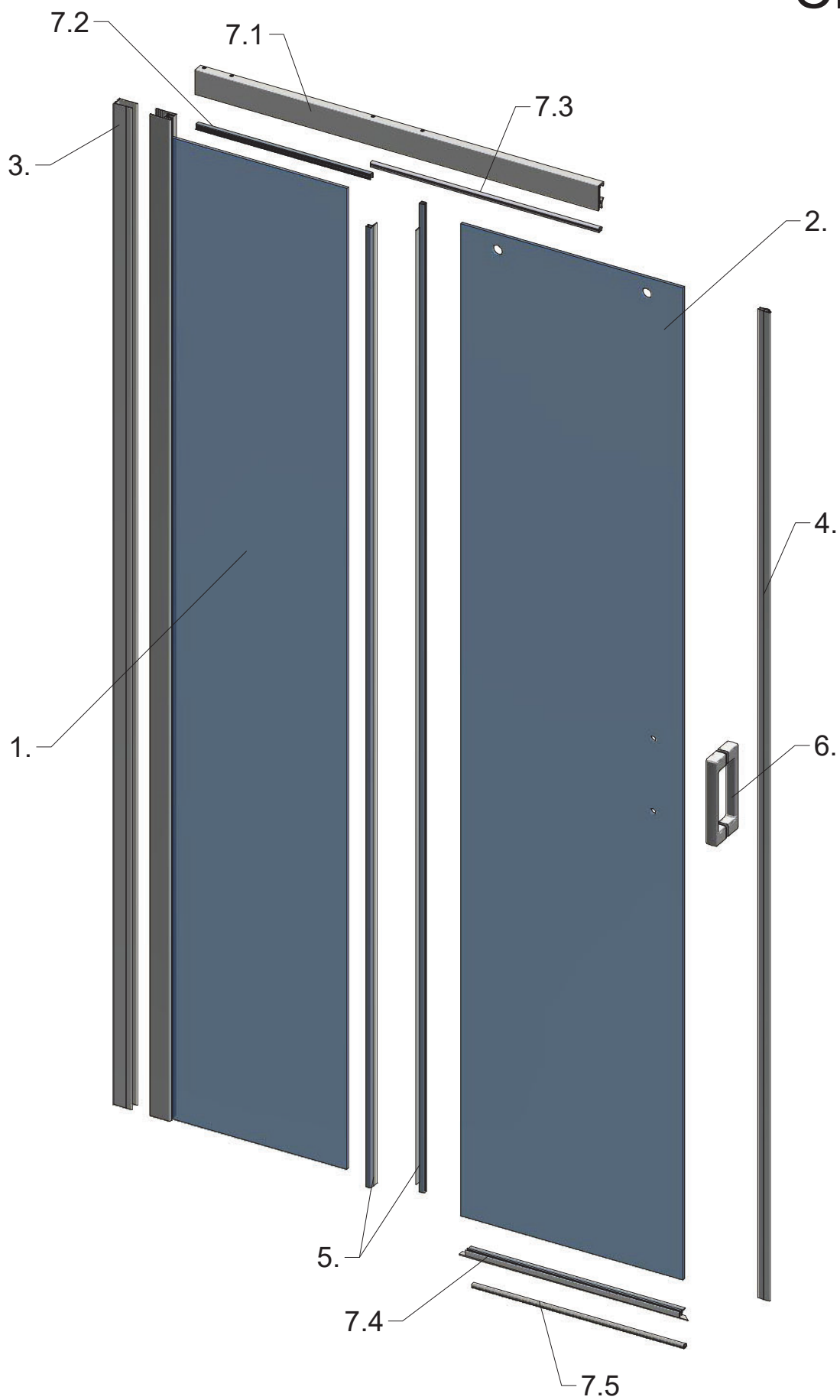

CI C2R

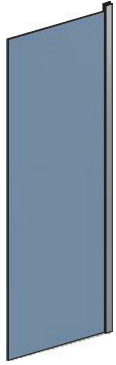



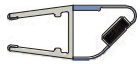





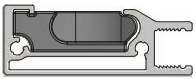

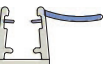





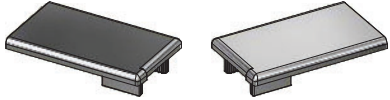

CI C2R VPE / NPE

POS.	PREVIEW	PCS	SPARE PART
1.		1	V302
2.		1	V303
3.		1	VPE (P5941) NPE (P6792)
4.		1	P6134
5.		2	P6127
6.		1	MA9198 (VPE) MB2332 (NPE)
7.	RAIL, STOPS, SEALS	1	P315
8.	ACCESSORIES	1	P6145 (VPE) P6864 (NPE)

7. P315

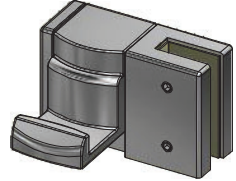
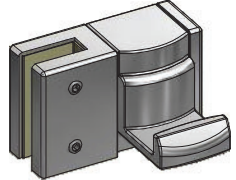
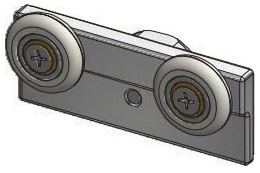
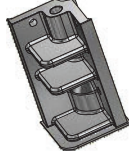



POS.	PREVIEW	PCS	SPARE PART
7.1		1	RAIL+STOPS
7.2		1	
7.3		1	
7.4		1	P6121
7.5		1	P6133 (VPE) P6809 (NPE)



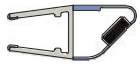

8. P6145 (VPE) / P6864 (NPE)

POS.	PREVIEW
8.1	1xL + 1xR 
8.2	2x 
8.3	6x ST3,9 
8.4	8x ST3,5 
8.5	6x 
8.6	6x 
8.7	6x 
8.8	6x 
8.9	MB1120 (VPE) MB2331 (NPE) 
8.10	MB1119 (VPE) MB2322 (NPE) 
8.11	4x MB1157 (VPE) MB2319 (NPE) 
8.12	
8.13	
8.14	
8.15	
8.16	

CI C2L VPE

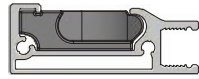
7. P315

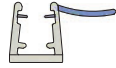
POS.	PREVIEW	PCS	SPARE PART
1.		1	V302
2.		1	V303
3.		1	(VPE) P5941 (NPE) P6792
4.		1	P6134
5.		2	P6127
6.		1	MA9198 (VPE) MB2332 (NPE)
7.	RAIL, STOPS, SEALS	1	P315

POS.	PREVIEW	PCS	SPARE PART
7.1		1	RAIL+STOPS
7.2		1	
7.3		1	
7.4		1	P6121
7.5		1	P6133 (VPE) P6809 (NPE)

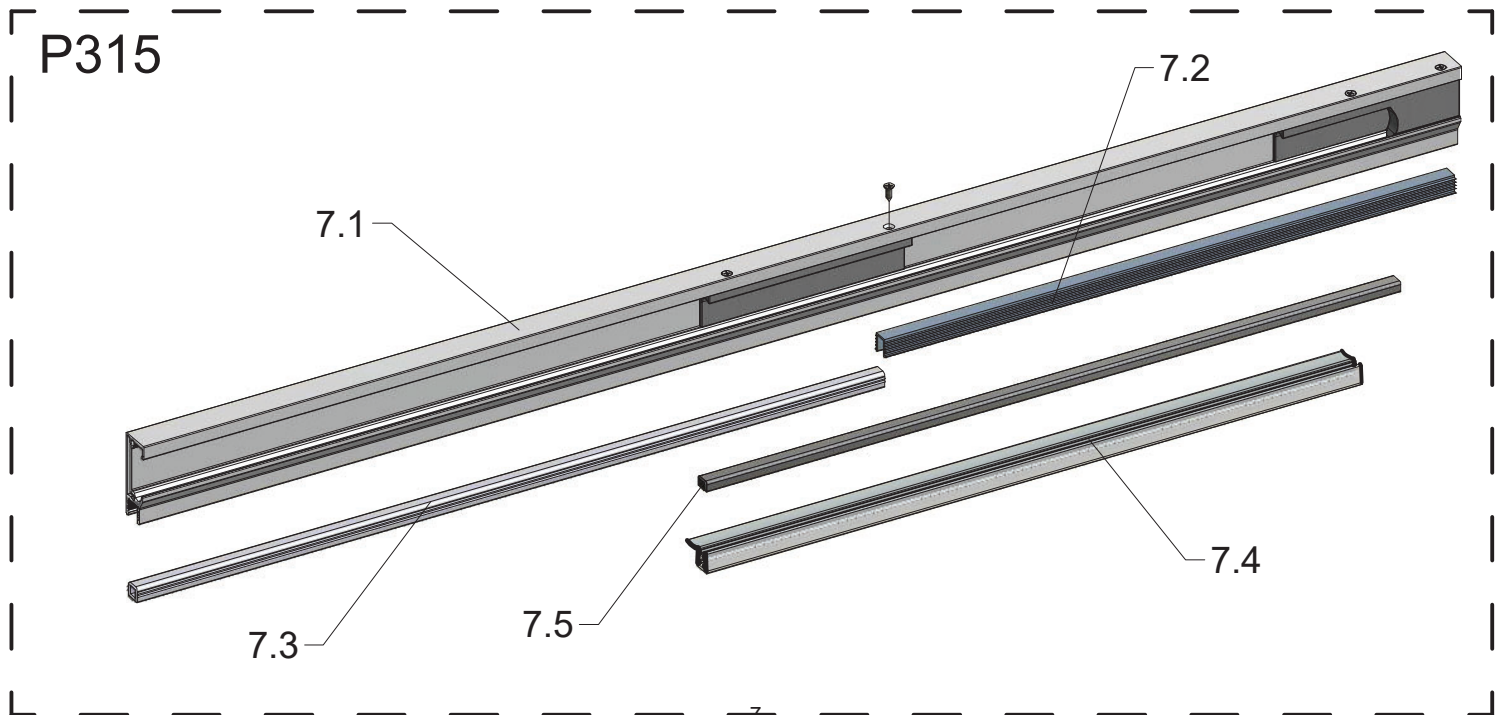

1. V302

SIZE	black + clear glass	brillant + clear glass
C2L 800	ND03-0955-05-02	ND03-0955-00-02
C2L 900	ND03-0956-05-02	ND03-0956-00-02
C2L 1000	ND03-0957-05-02	ND03-0957-00-02
C2L 1100	ND03-0958-05-02	ND03-0958-00-02
C2L 1200	ND03-0959-05-02	ND03-0959-00-02
C2R 800	ND03-0960-05-02	ND03-0960-00-02
C2R 900	ND03-0961-05-02	ND03-0961-00-02
C2R 1000	ND03-0962-05-02	ND03-0962-00-02
C2R 1100	ND03-0963-05-02	ND03-0963-00-02
C2R 1200	ND03-0964-05-02	ND03-0964-00-02

2. V303

SIZE	GLASS	SPARE PART
800	clear glass	ND02-0944-02
900	clear glass	ND02-0945-02
1000	clear glass	ND02-0946-02
1100	clear glass	ND02-0947-02
1200	clear glass	ND02-0948-02

7. P315

SIZE	black profile	brillant profile
C2L 800	P6859	P6210
C2L 900	P6860	P6212
C2L 1000	P6861	P6214
C2L 1100	P6862	P6216
C2L 1200	P6863	P6218
C2R 800	P6854	P6211
C2R 900	P6855	P6213
C2R 1000	P6856	P6215
C2R 1100	P6857	P6217
C2R 1200	P6858	P6219